

TC-35i Modem for Tramigo fleet software.

Package contents:

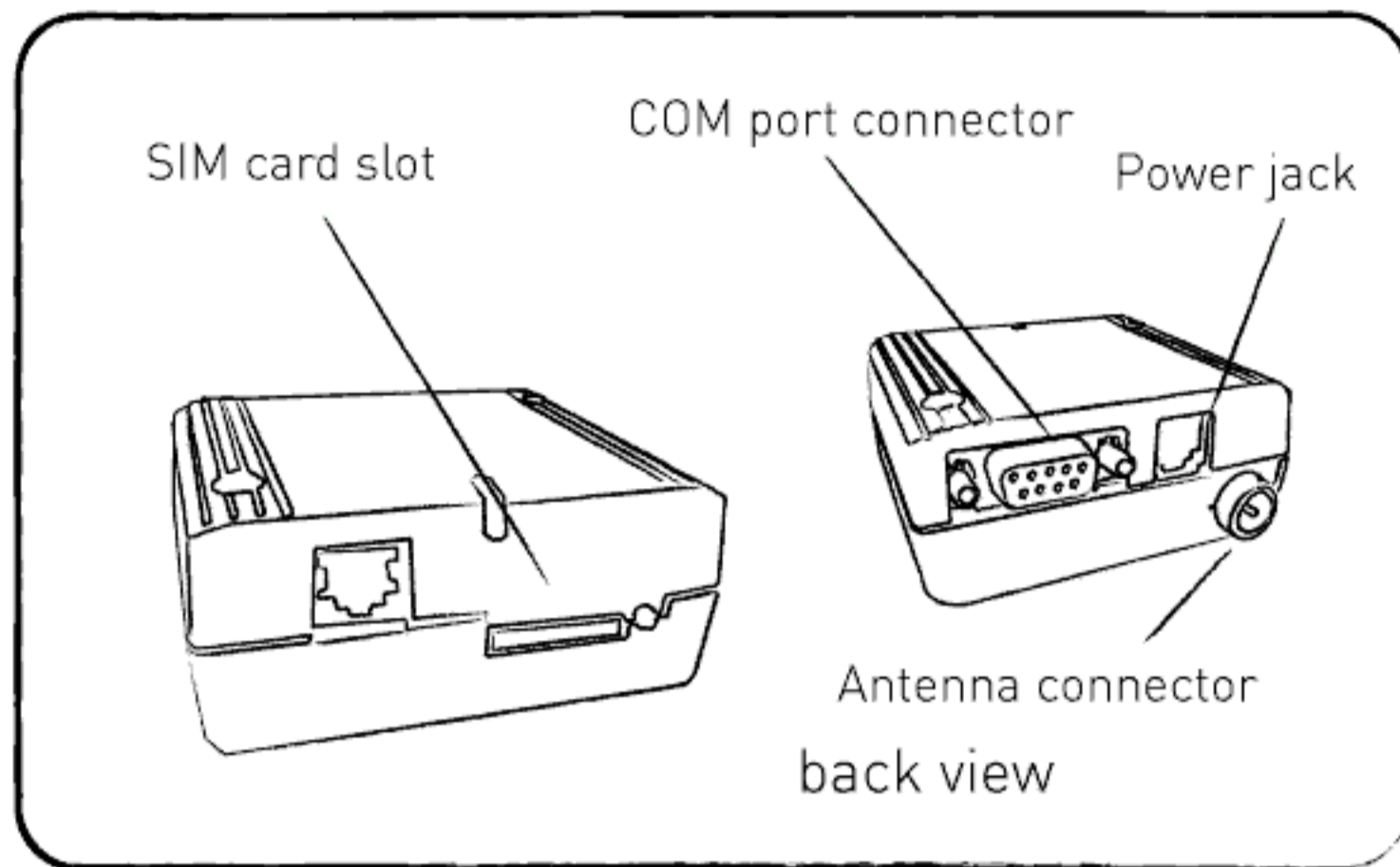

1x Siemens TC-35i modem



1x Driver disk

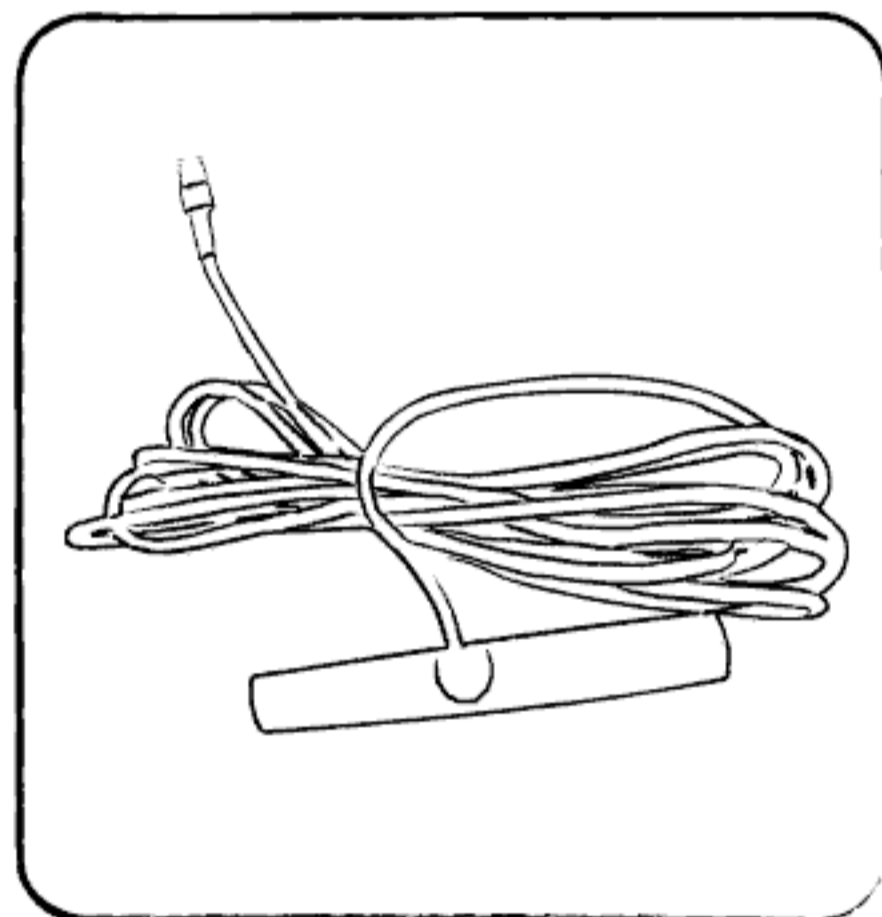

1x TC-35i GSM
antenna

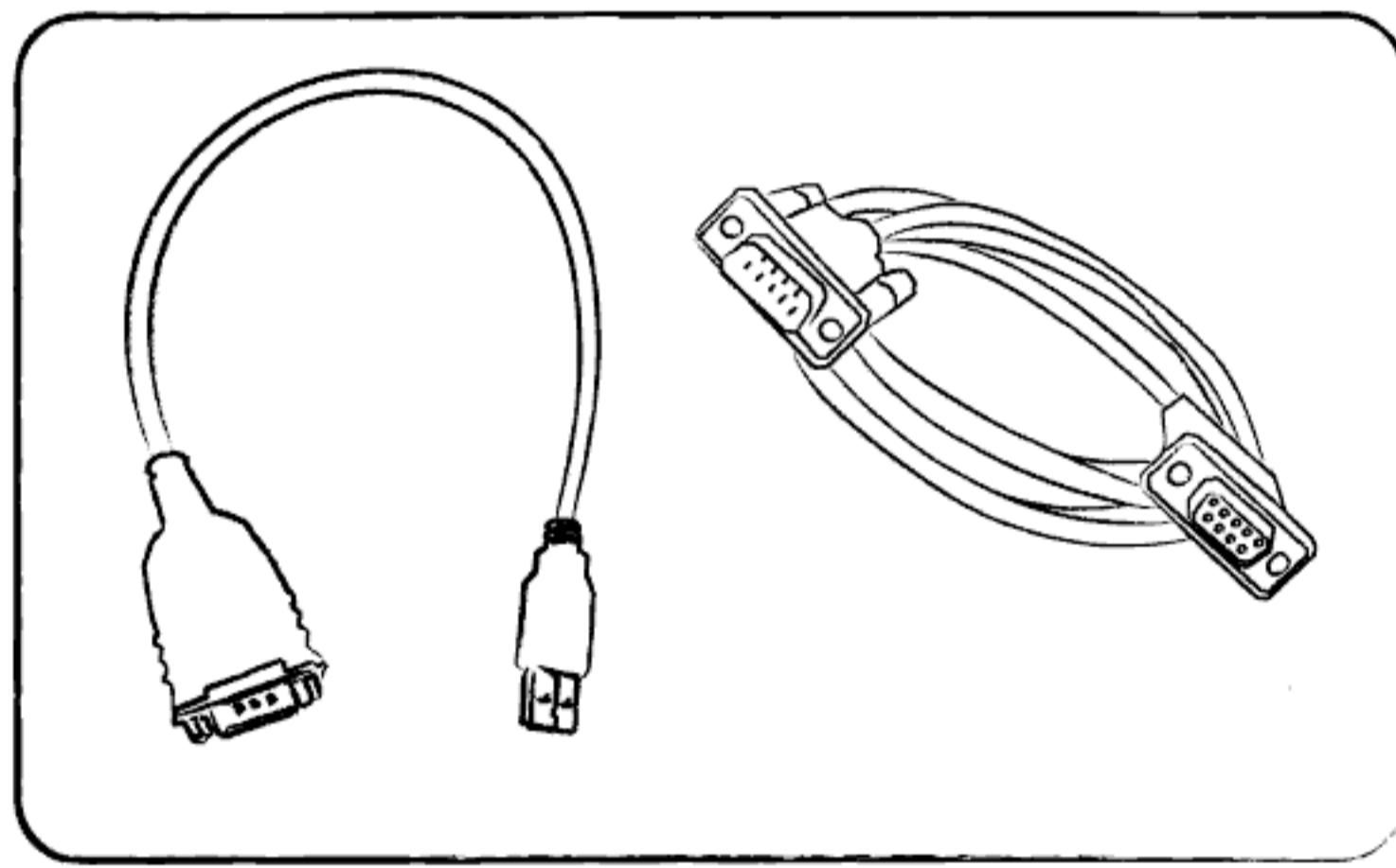

1x 9 pin serial cable and 1x - USB
adaptor cable

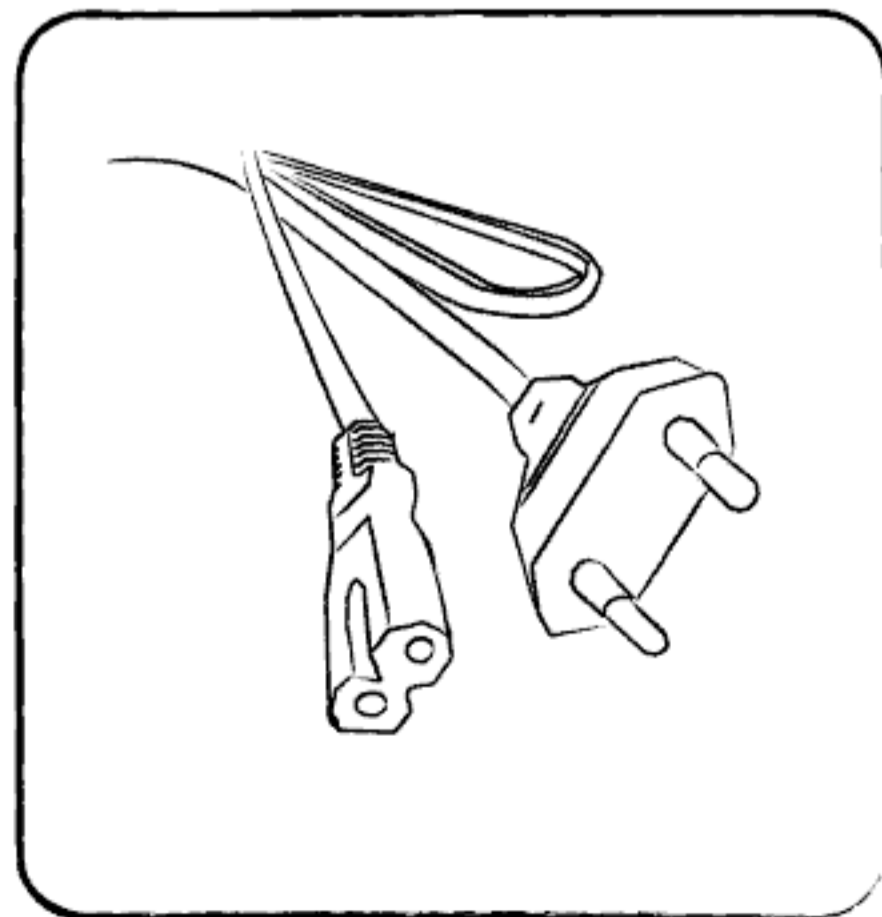

1x power supply cable

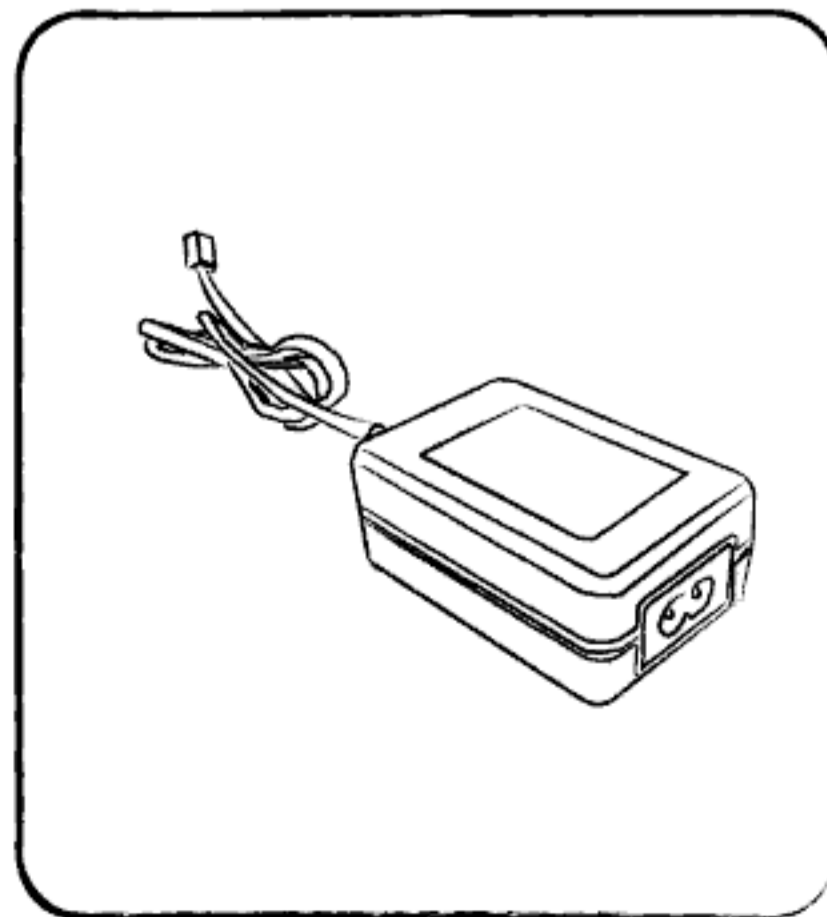

1x power supply

TC-35i Modem Installation for desktop computers.

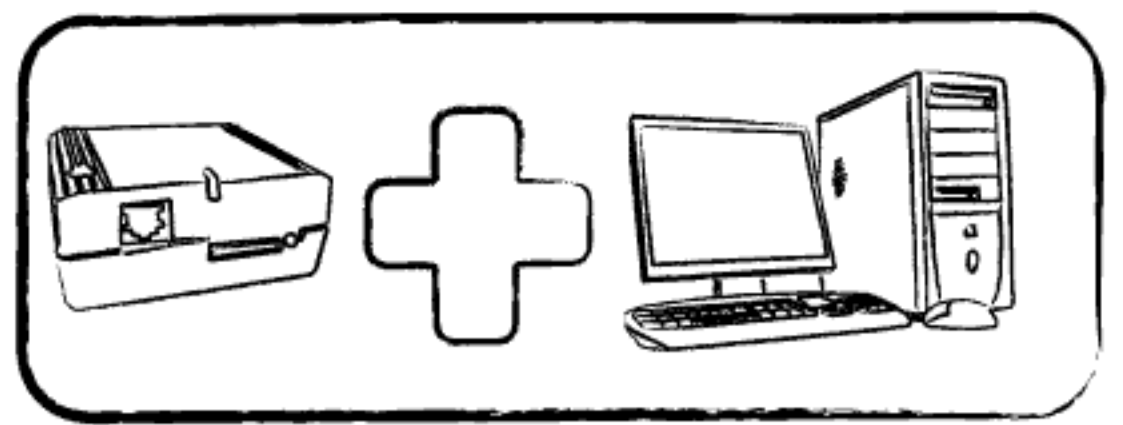

1

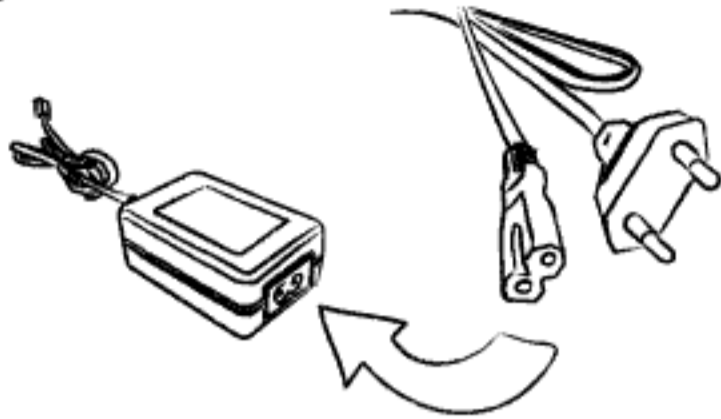

Connect power cord to power supply

2

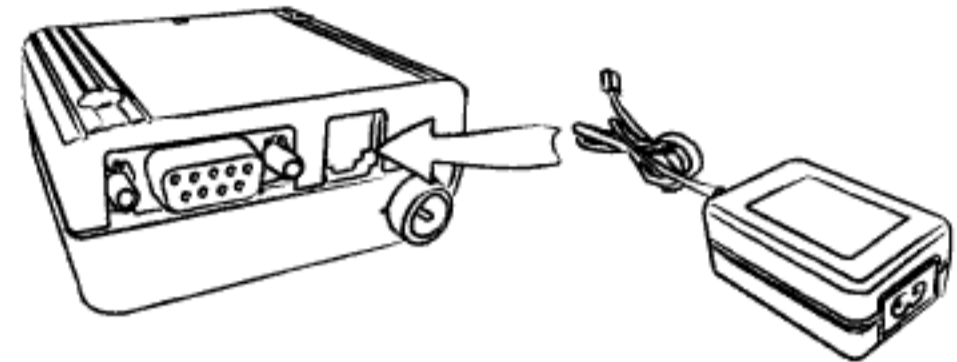

Connect power supply to the rightmost slot in the TC-35i.

3

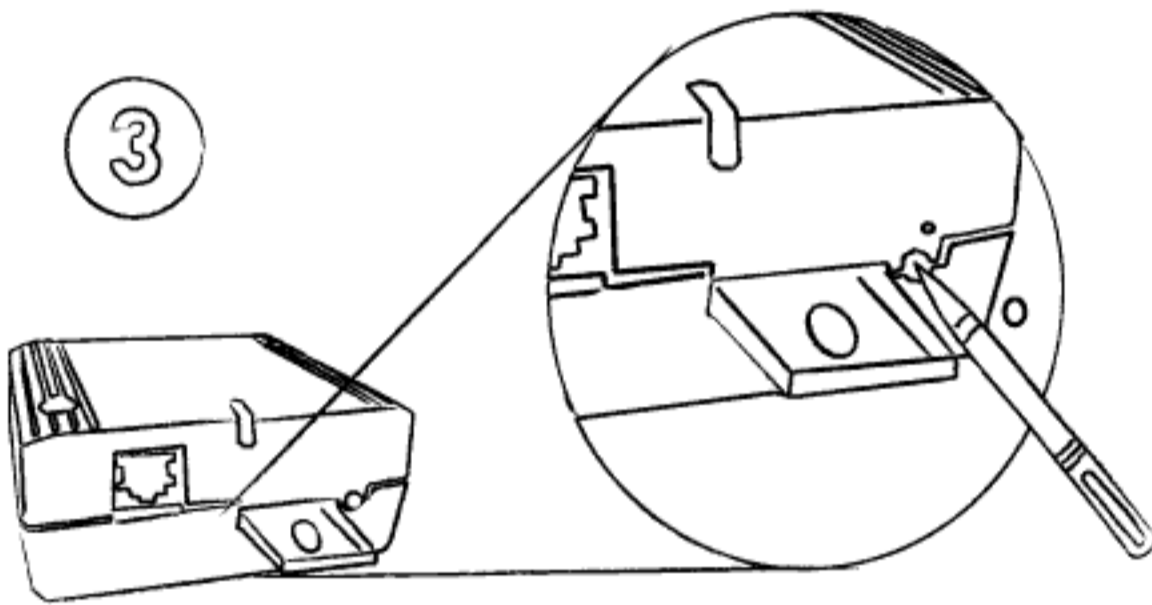

Open the SIM card slot by pressing the yellow button with a pointed object.

4

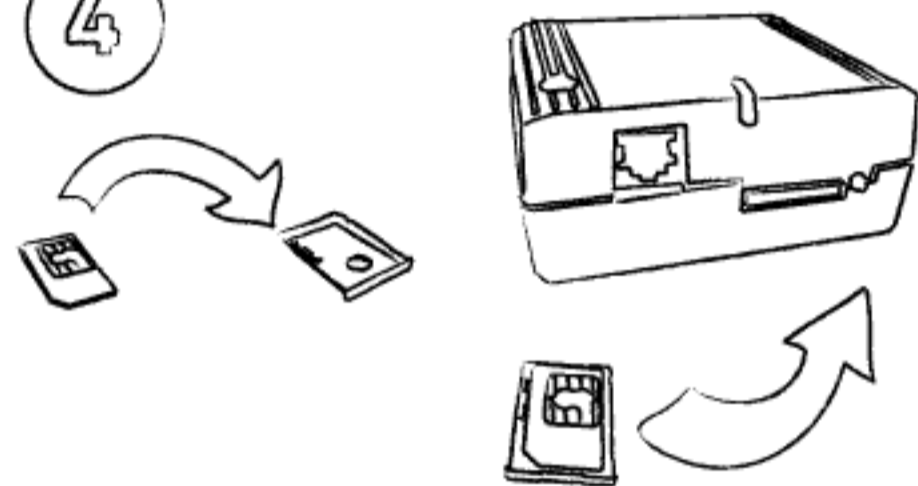

Install SIM with chip facing UP into the modem card slot.

5

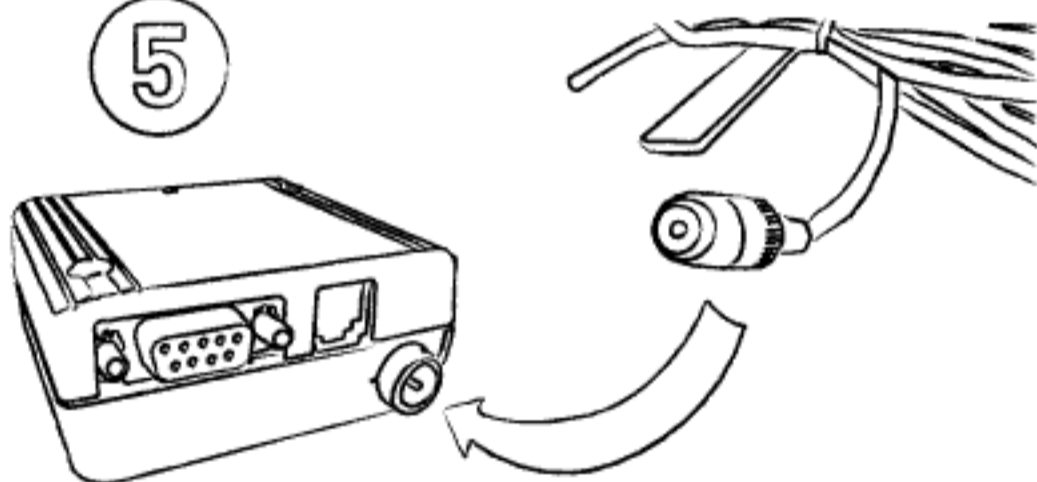

Attach and screw on the Antenna.

6

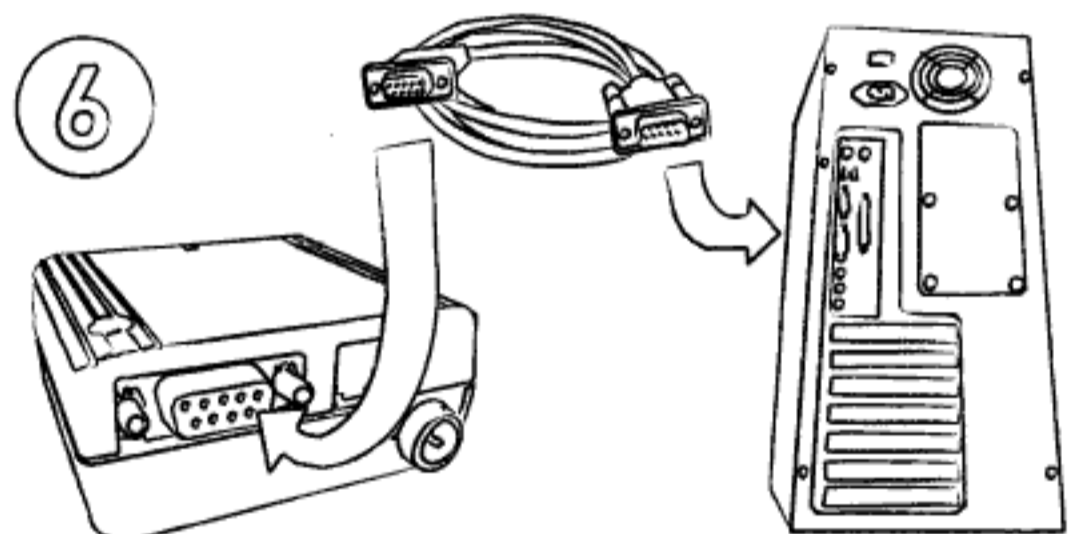

Connect the modem cable to the PC Com port and the TC35i serial port.

7

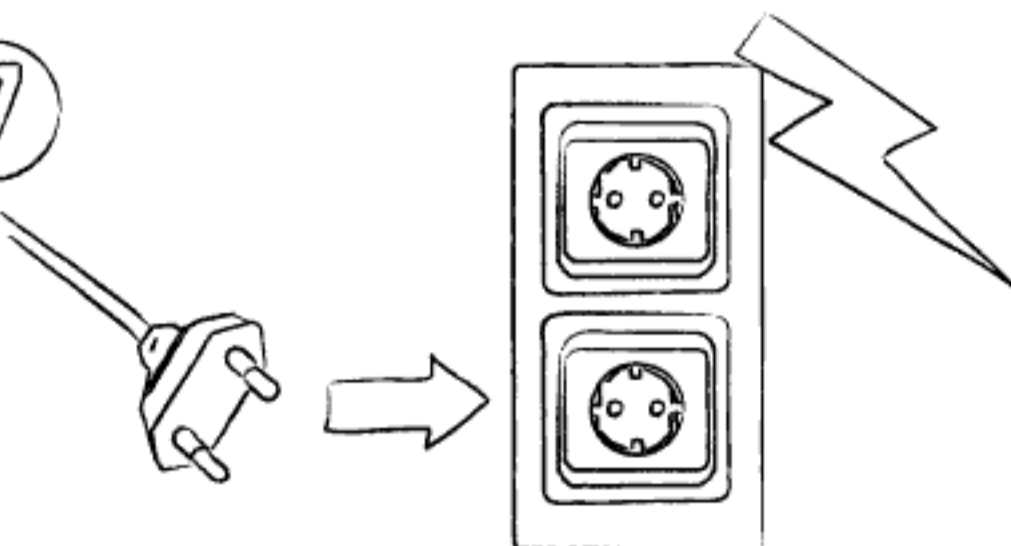

Plug in the power cable to an electric-ity socket.

8

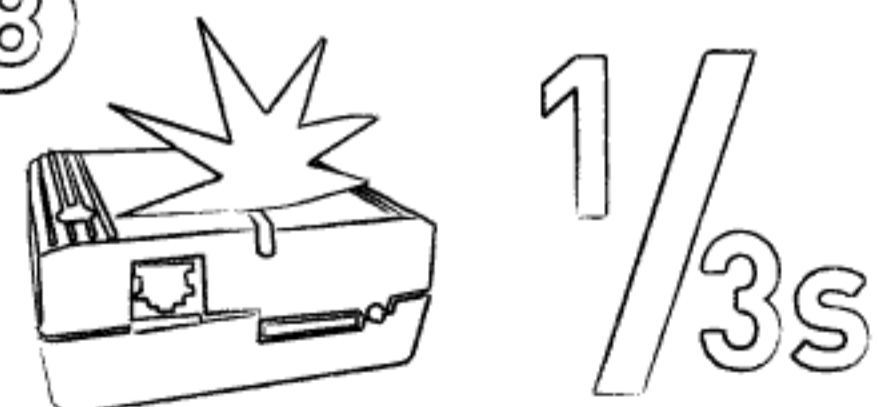

Observe the light. It should soon start blinking once every 3 seconds.

TC-35i Modem Installation for laptop computers.

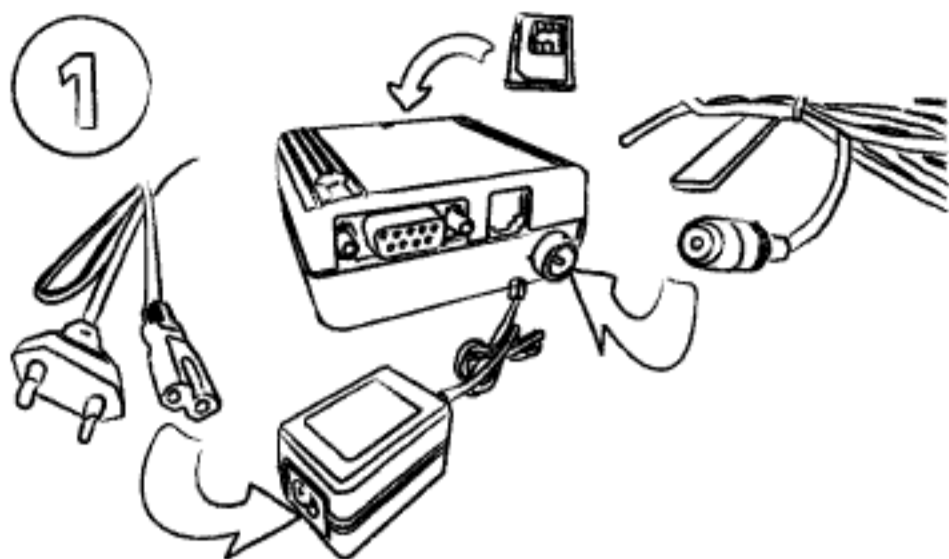
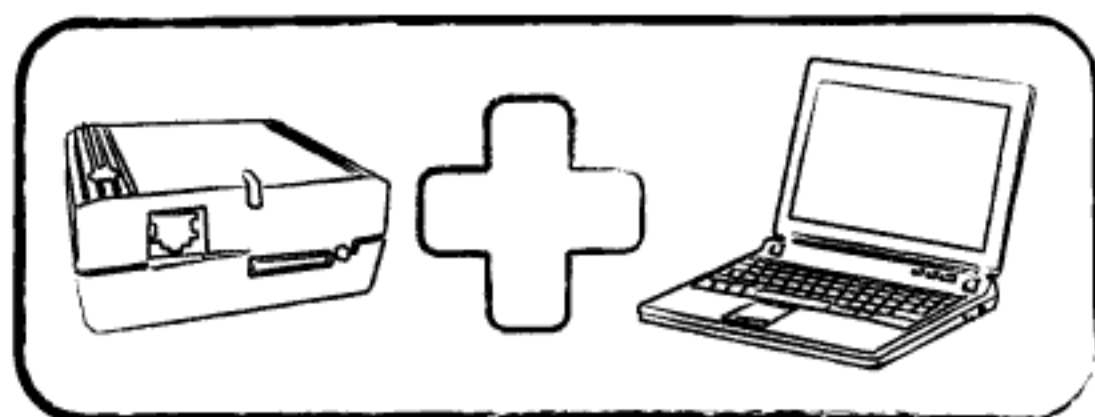

1 Setup TC-65 as in tabletop installation steps 1-5.

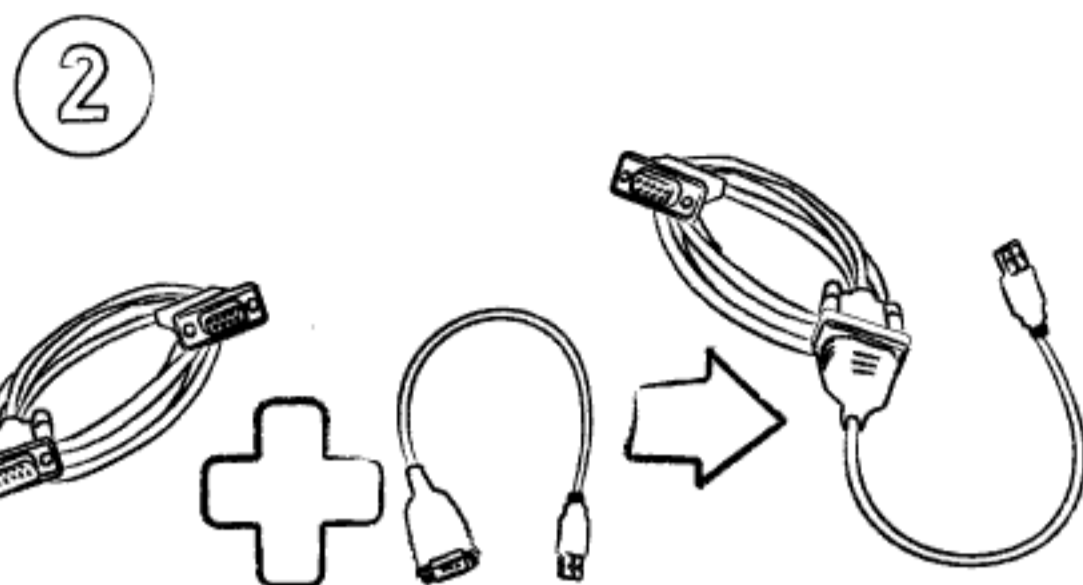

2 Connect the USB adaptor cable to the 9-pin modem cable.



3 Insert the driver disk into the CD-Rom drive.



4 Select your operating system and choose the drivers for serial to USB.

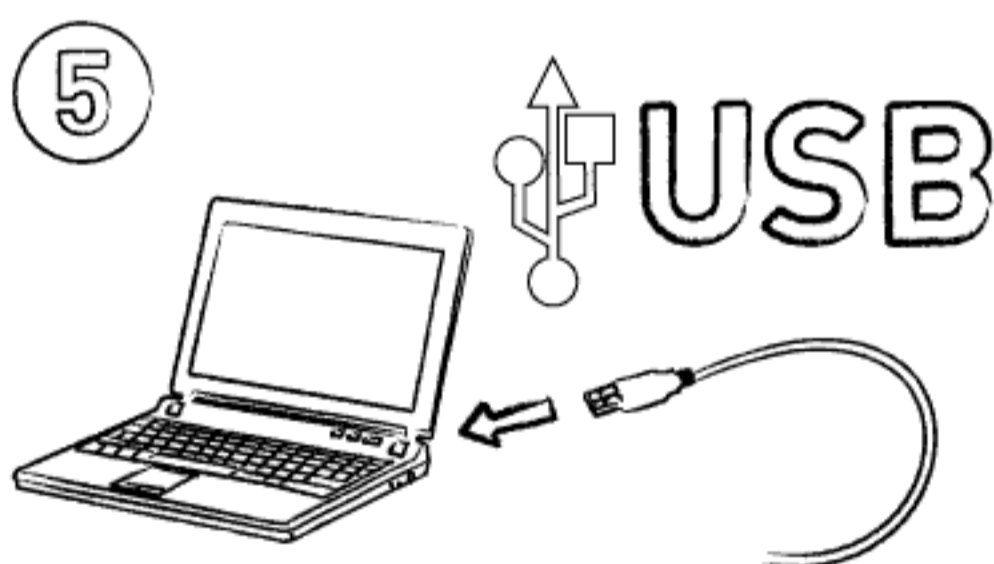

5 Connect the serial-USB adaptor to your USB port.

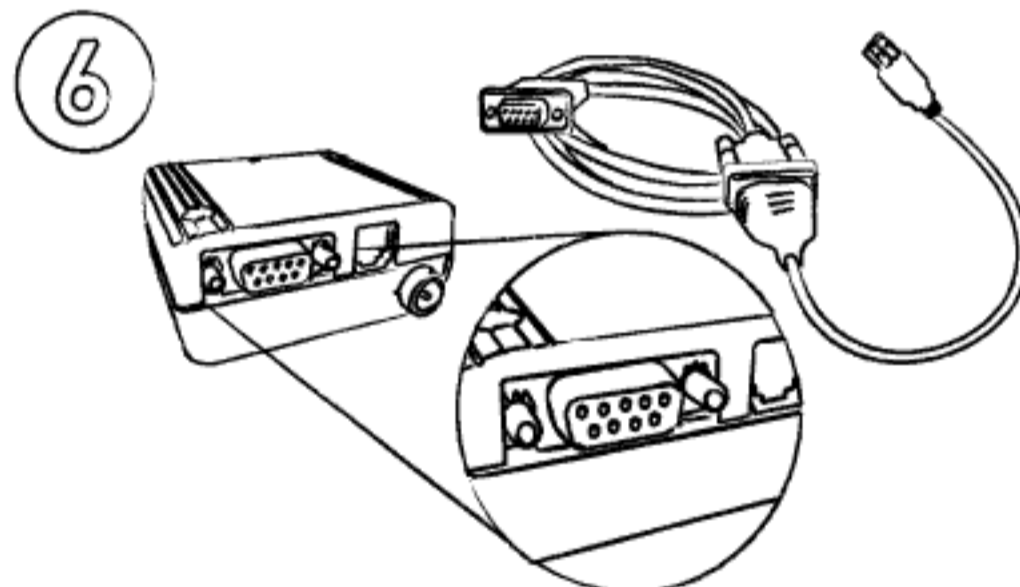

6 Connect the other end of the modem cable to your TC-35i Modem.

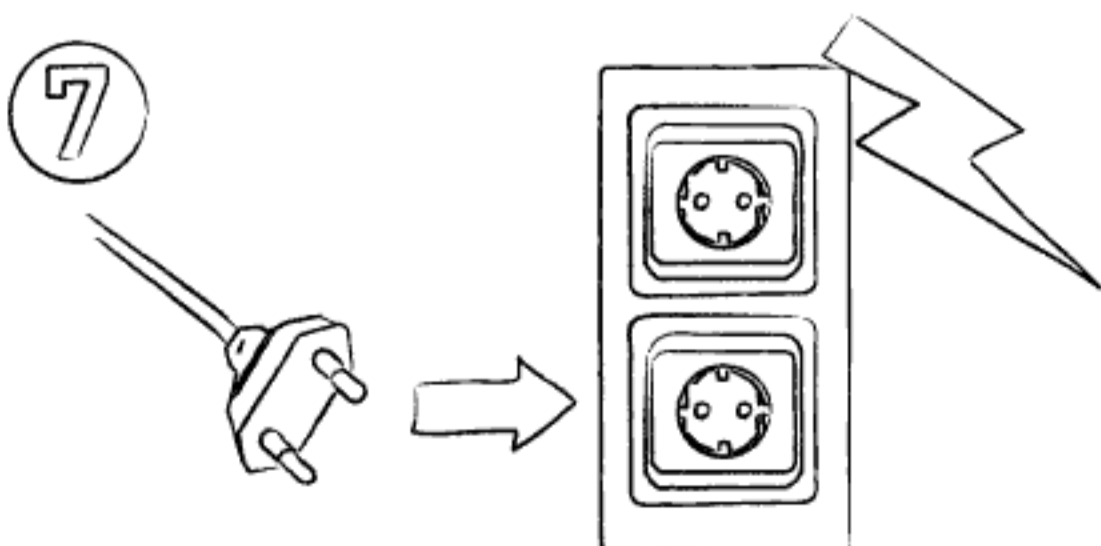

7 Plug in the power cable to an electricity socket.

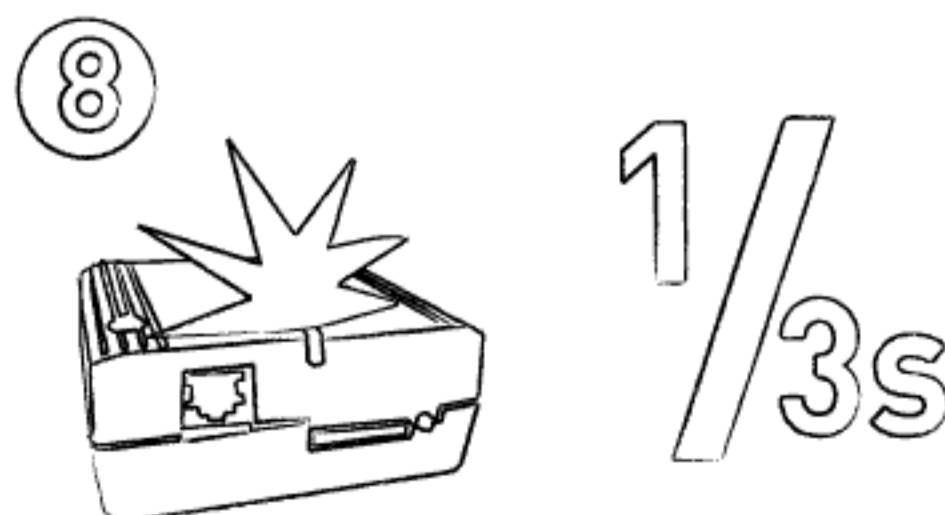

8 Observe the light. It should soon start blinking once every 3 seconds.